

Inovação e Propriedade Intelectual

Samuel Simões

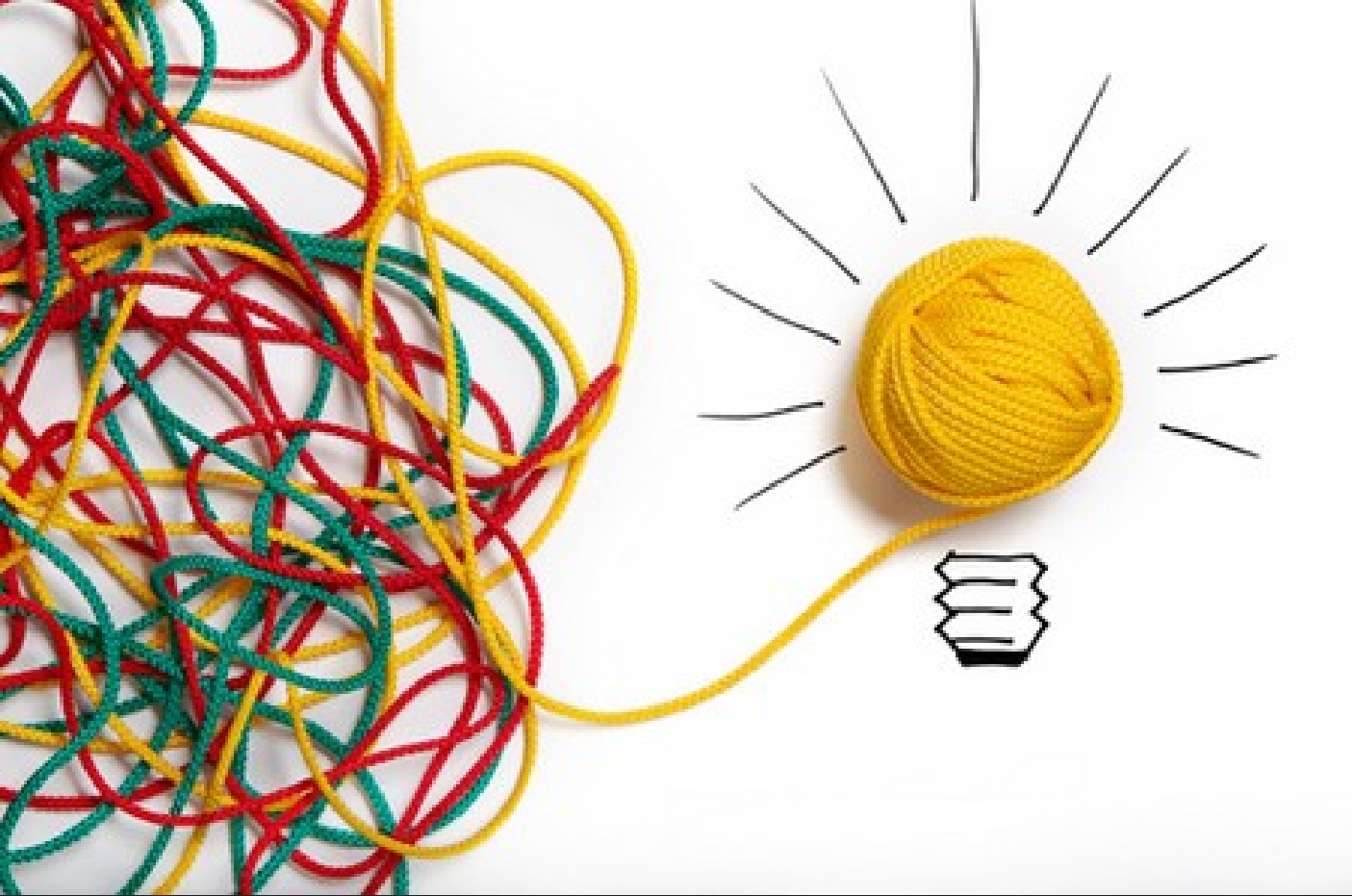

1. INOVAÇÃO

2. MUDANÇA



3. CULTURA





4. MEDO

5. CONHECIMENTO

6. TEMPO

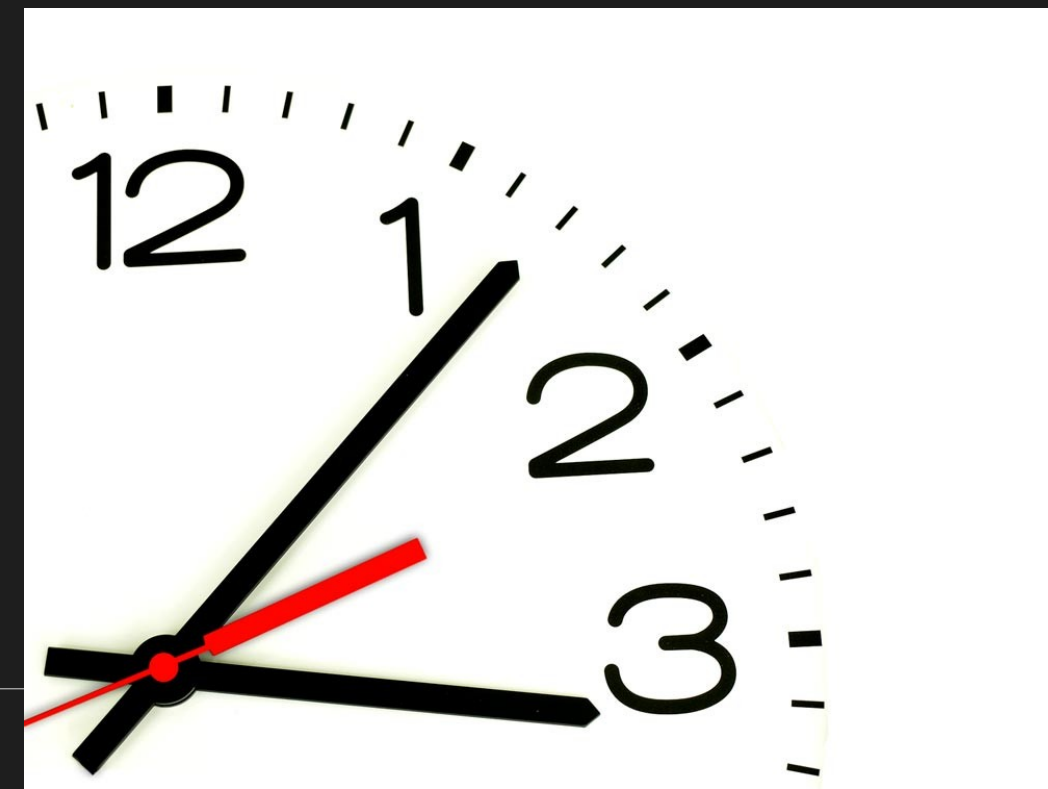

7. POSSIBILIDADES

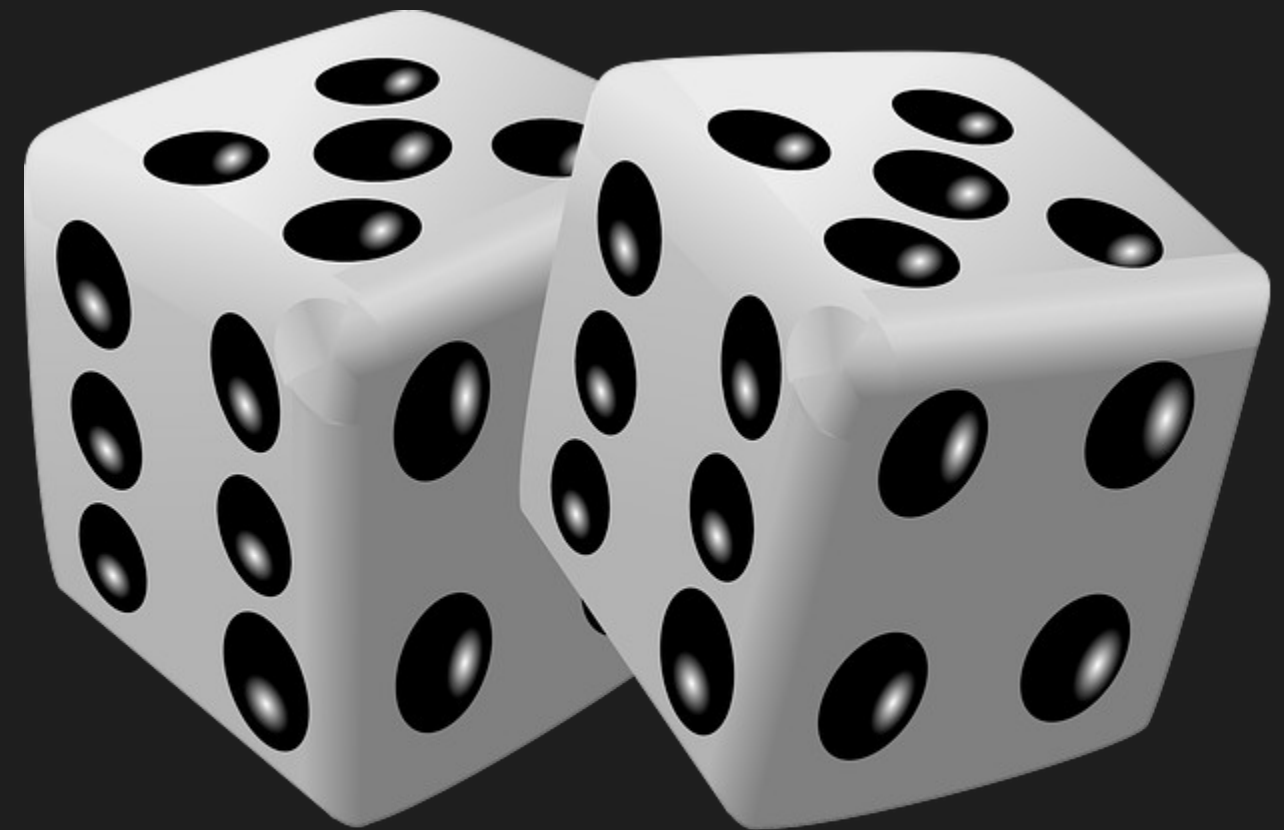

8. 6F

Fundamentos
Formatos
Funcionalidades
Flexibilidade
Facilidade
Futuro

9. PESSOAS



10. ENGAJAMENTO

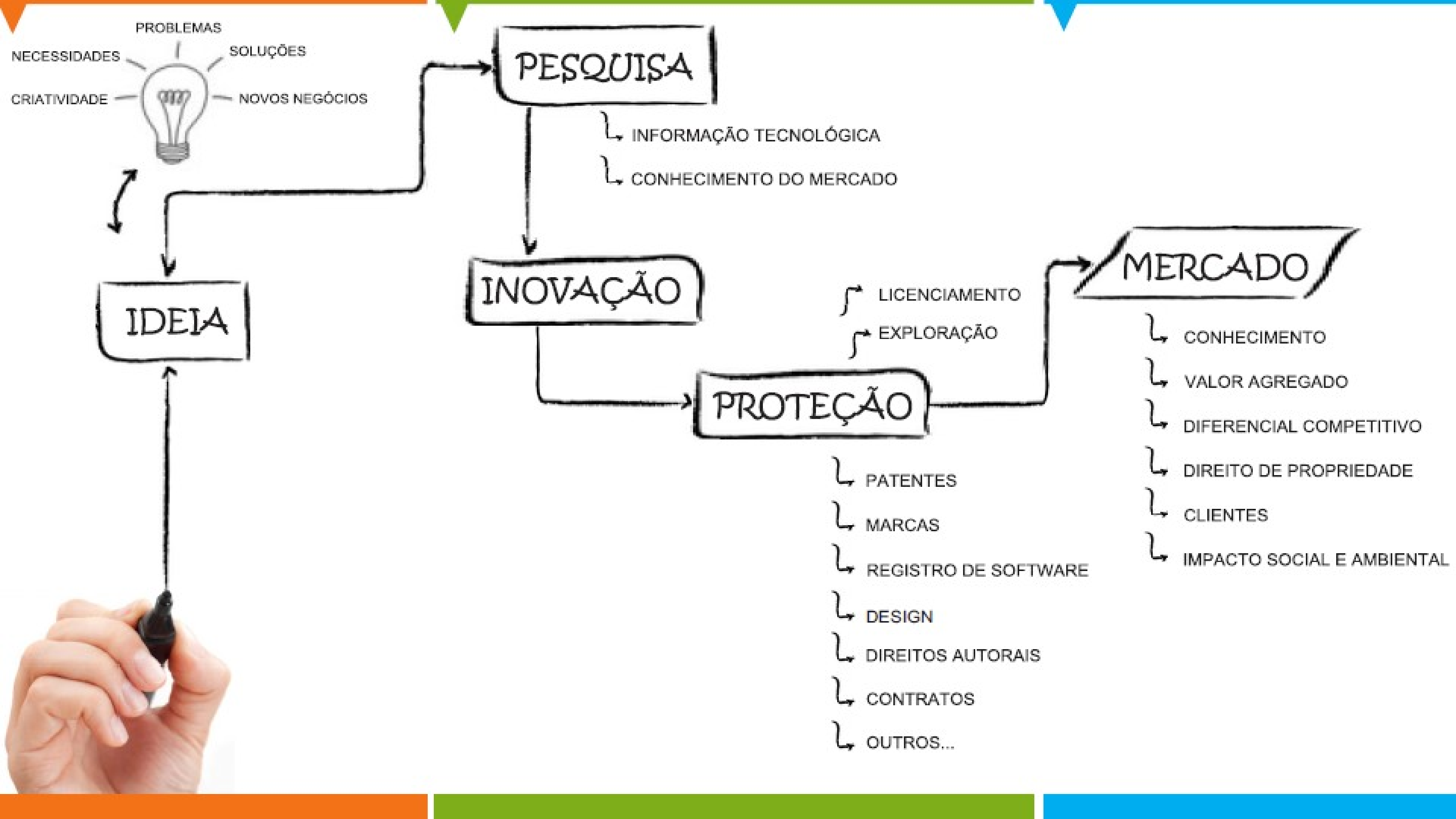

PESQUISA

↳ INFORMAÇÃO TECNOLÓGICA

↳ CONHECIMENTO DO MERCADO

VIABILIDADE !

POSSIBILIDADE!

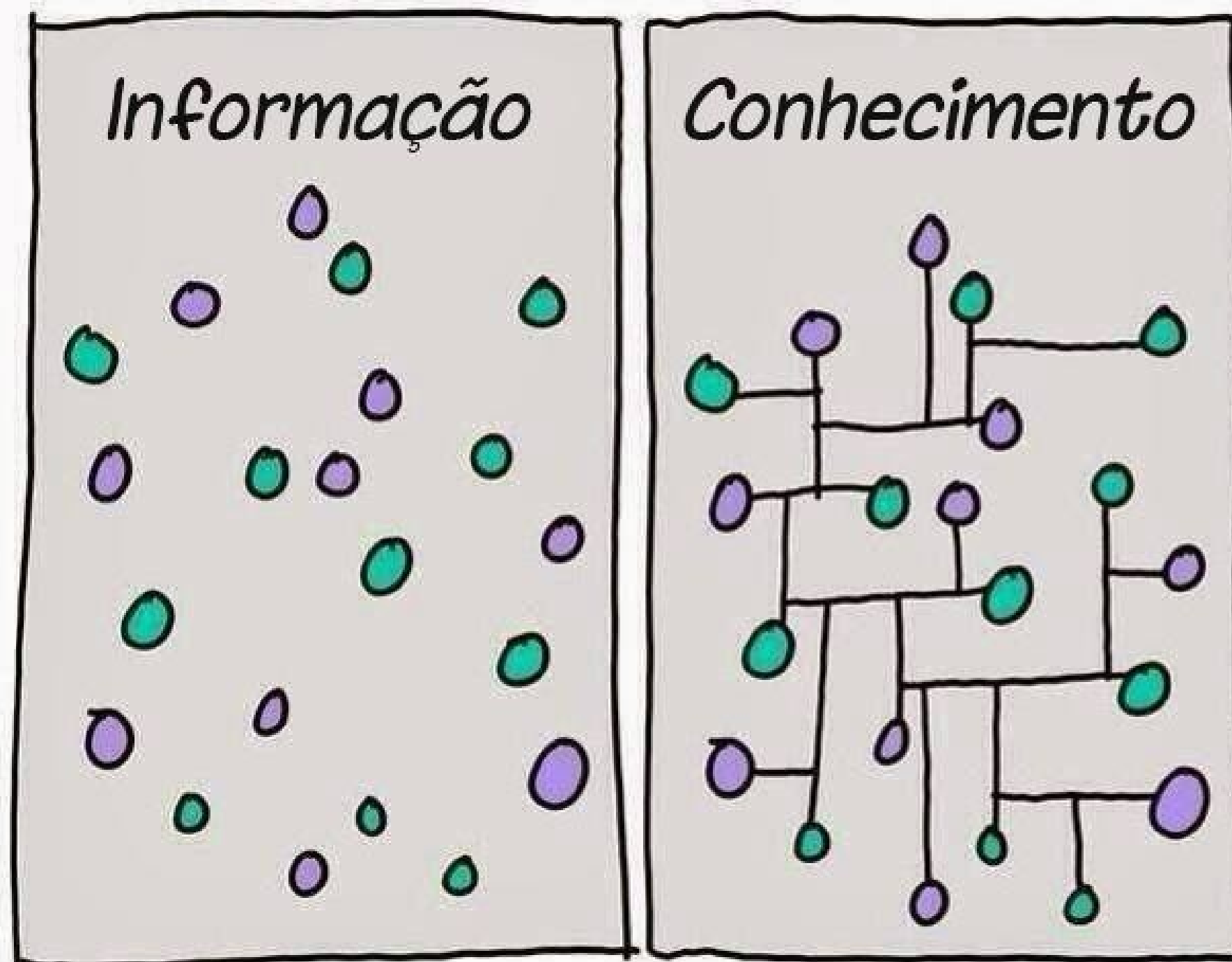

@gapingvoid

Bases de Informações Tecnológicas

80% da tecnologia tem divulgação exclusiva por patentes; restante tem por outros meios, como periódicos;

Abrange todos os campos tecnológicos com informações padronizadas e Classificadas;
8,6 milhões de Patentes em Vigor no Mundo...

2,2 milhões de Patentes dos EUA

1,7 milhões de Patentes dos Japão

900 mil patentes da China

2,3 milhões de patentes foram solicitadas no Mundo em 2012

Território em que a tecnologia está Protegida e Onde está Disponível

“Estudo feito na **Alemanha** concluiu que os custos de P&D poderiam ser reduzidos em **30%**, caso a informação técnica disponível (neste caso **documentos de patentes**) fosse **melhor utilizada**”.

LICENCIAMENTO
EXPLORAÇÃO

PROTEÇÃO

- ↳ PATENTES
- ↳ MARCAS
- ↳ REGISTRO DE SOFTWARE
- ↳ DESIGN
- ↳ DIREITOS AUTORAIS
- ↳ CONTRATOS
- ↳ OUTROS... (LATTES)

ESTRATÉGIAS

- Patente US6286999
- Inventada dentro da Universidade de Stanford
- Foi importante para Atrair Investidores Anjos (Andy Bechtolsheimer e depois Kleiner Perkins e Sequóia Capital)
- Rendeu US\$336 milhões em Royalties para a Universidade

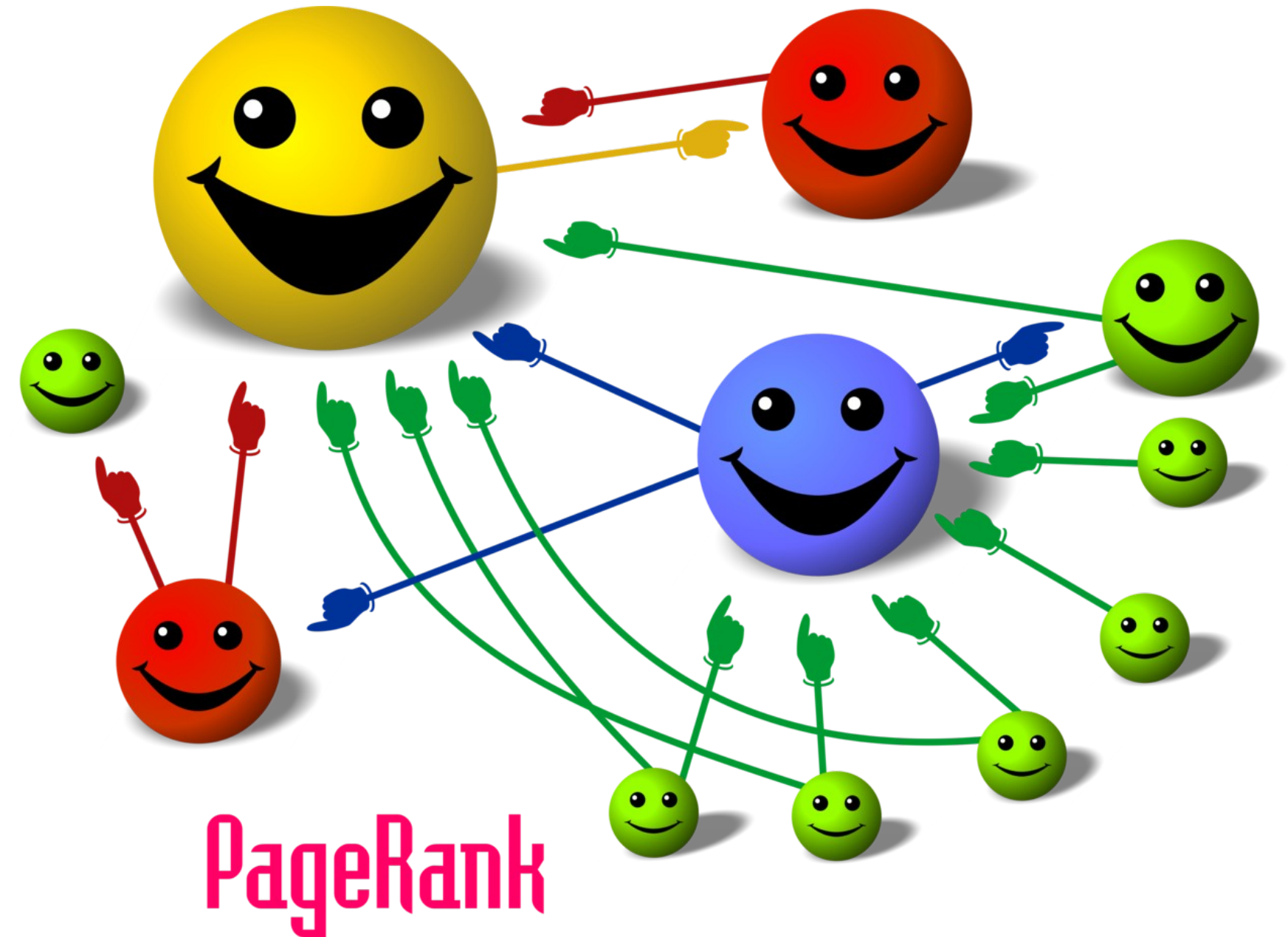

Formats

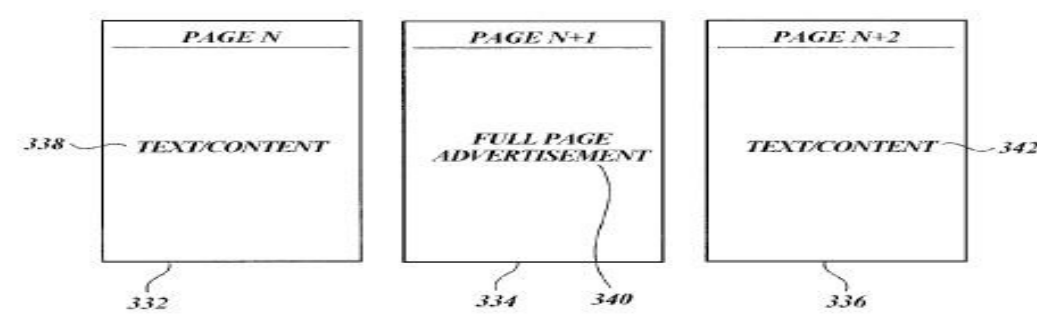
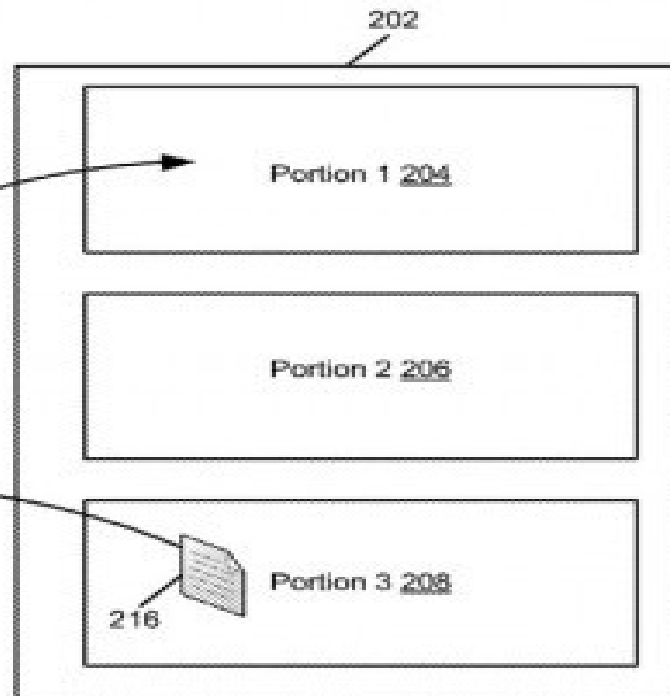
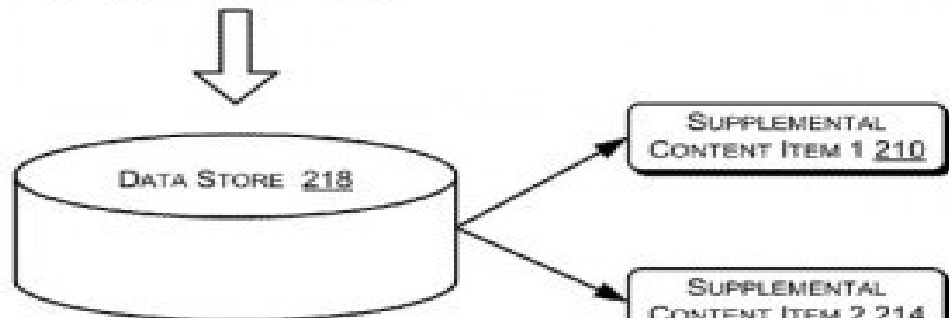
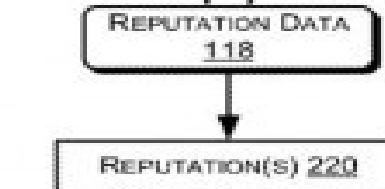

Fig.3A.

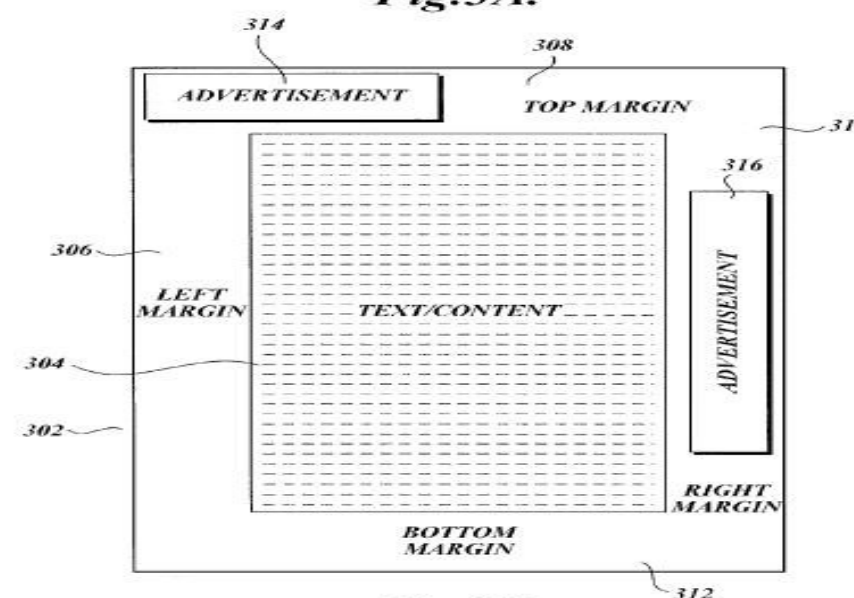
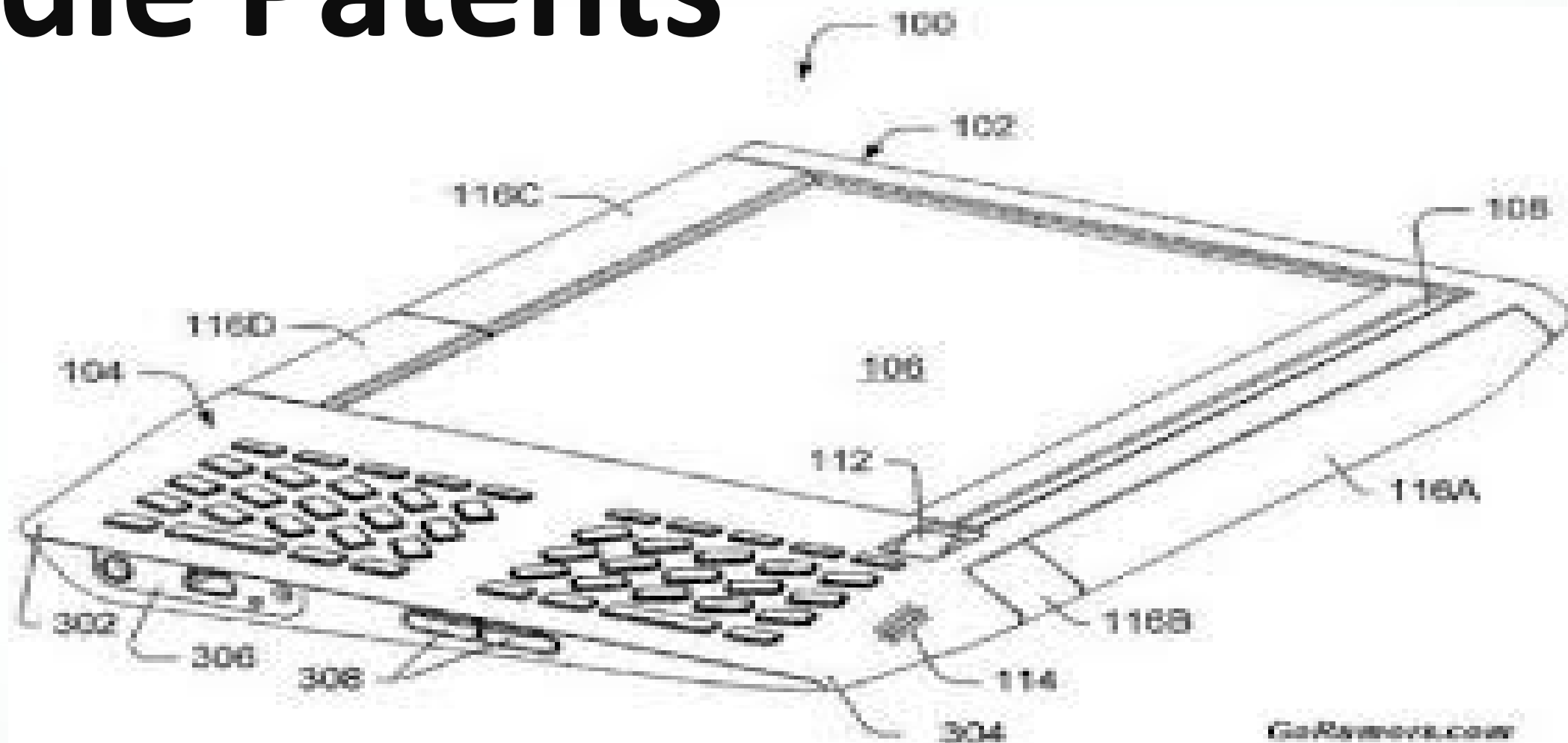
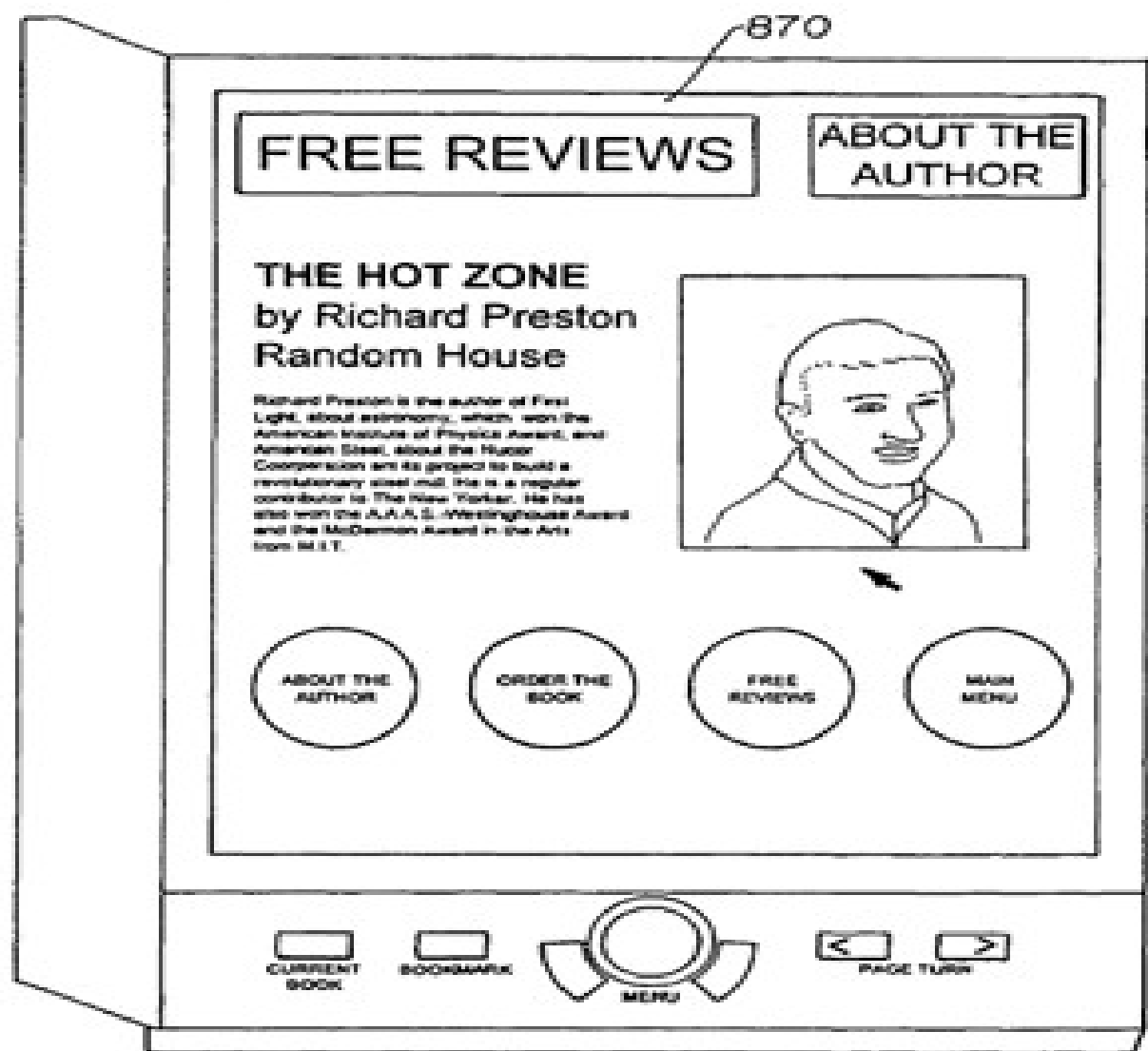
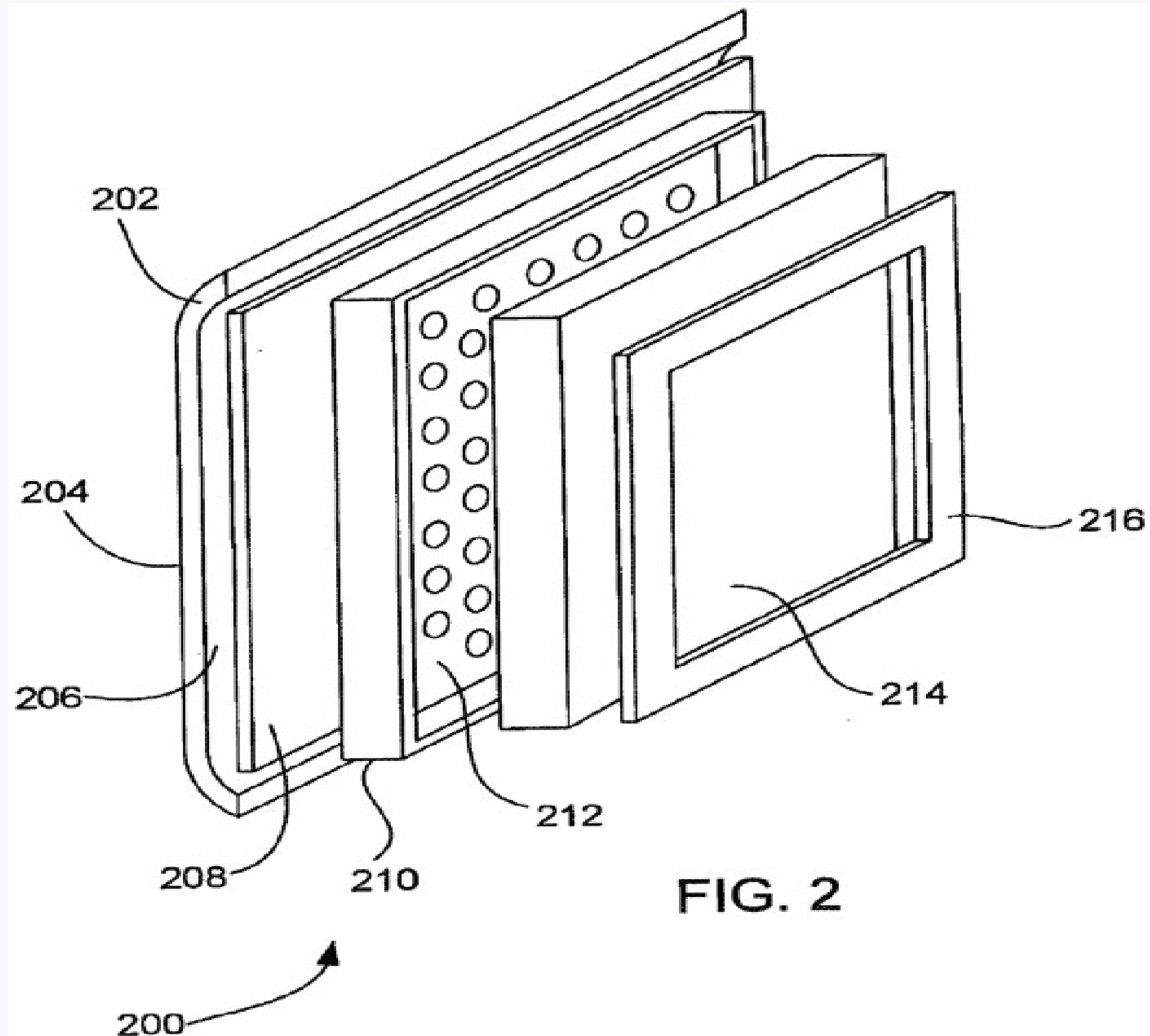

Fig.3B.

Kindle Patents





Iphone

Iphone

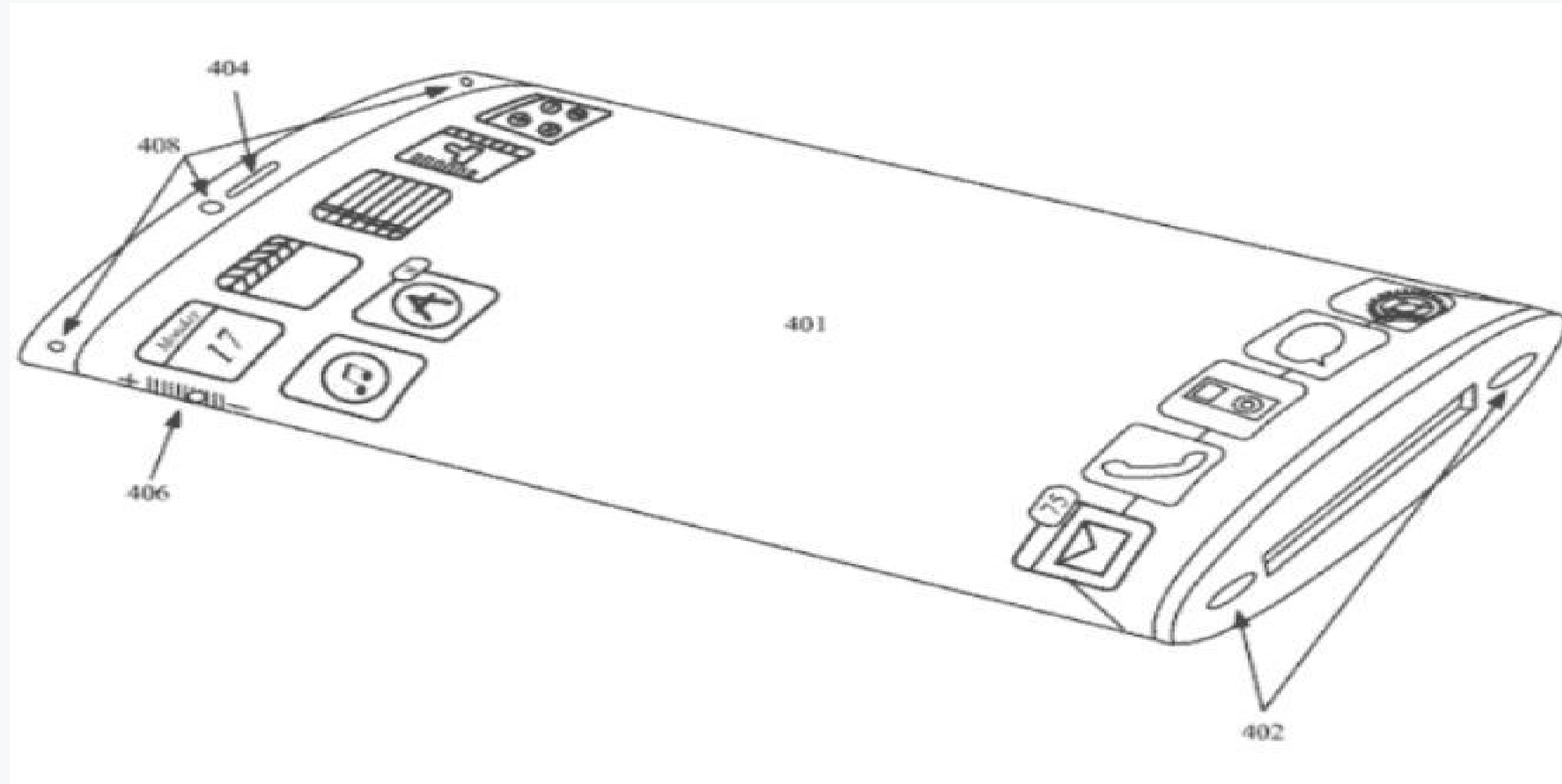

Formatos

Google Glass

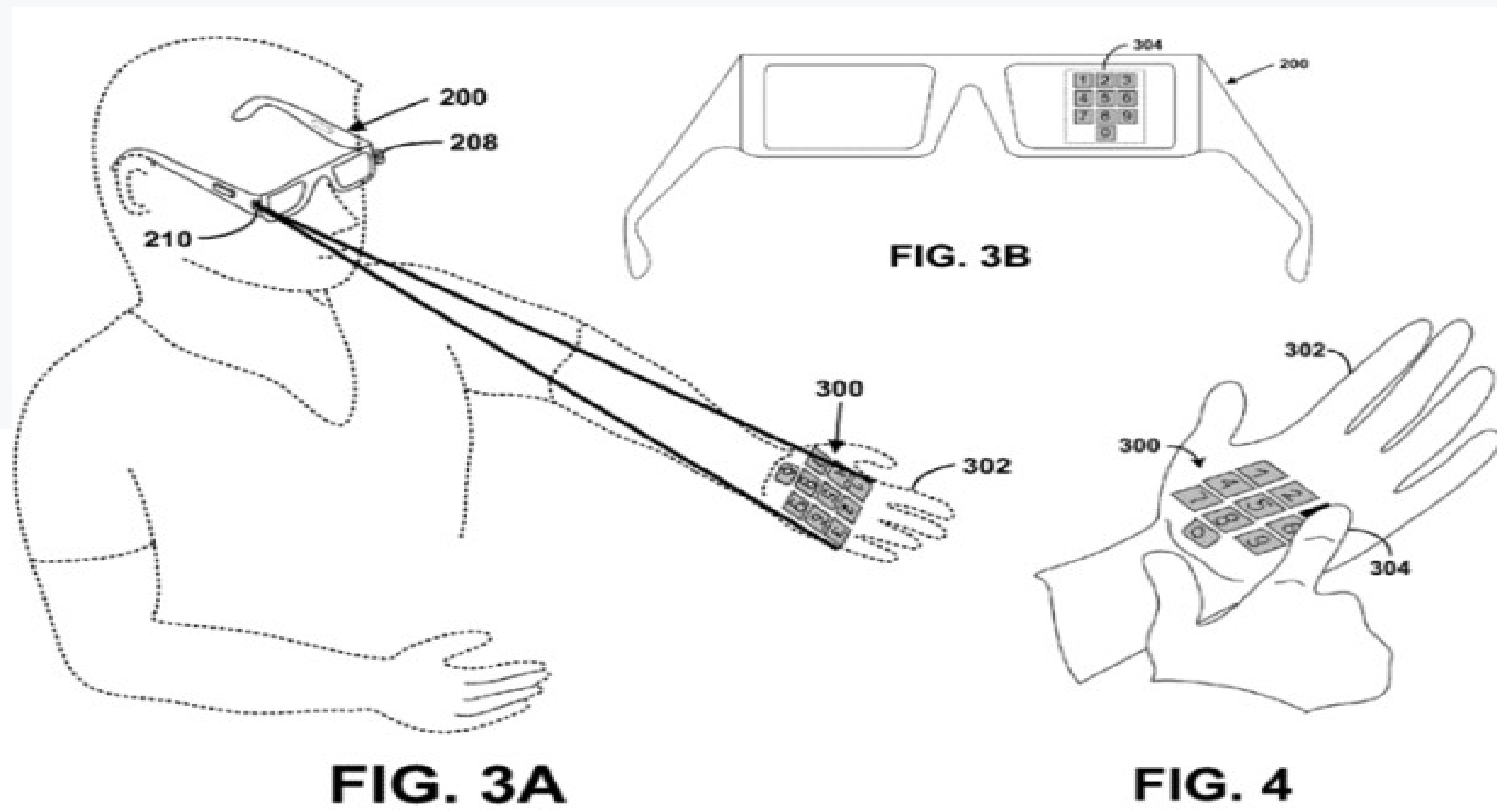
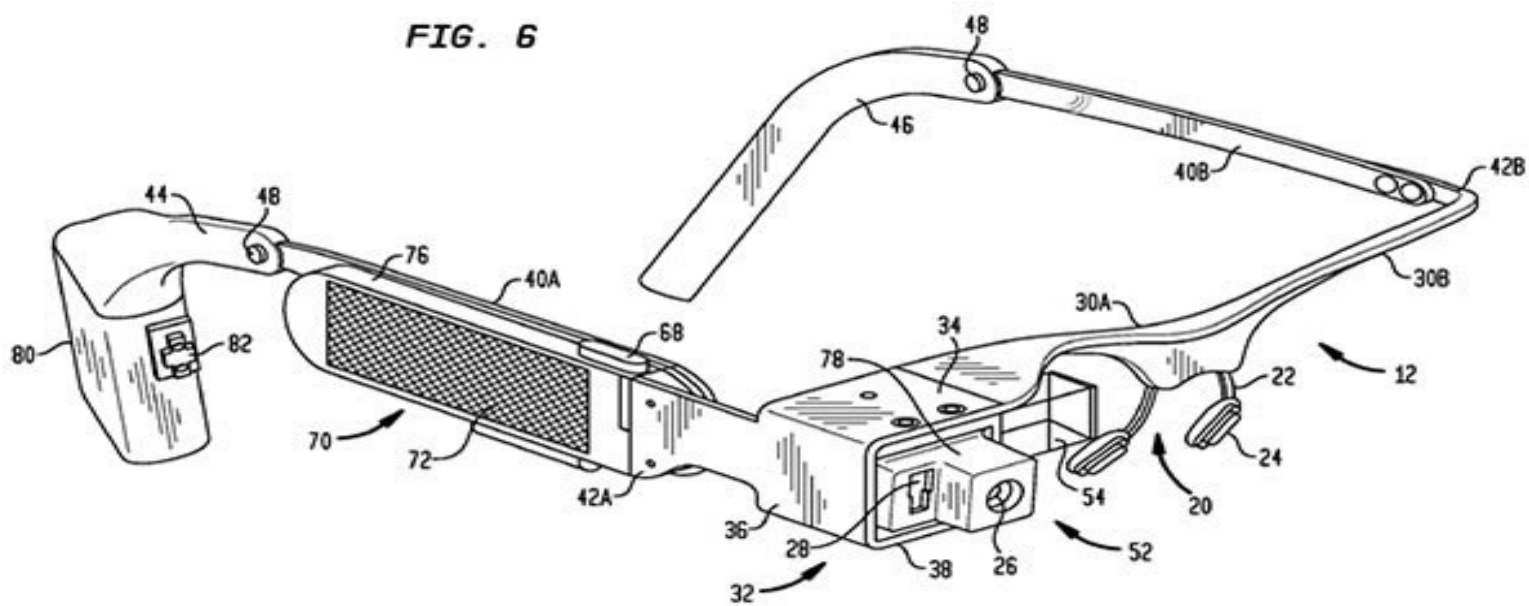

Balde retrátil

Flexibilidade



Campainha de piano

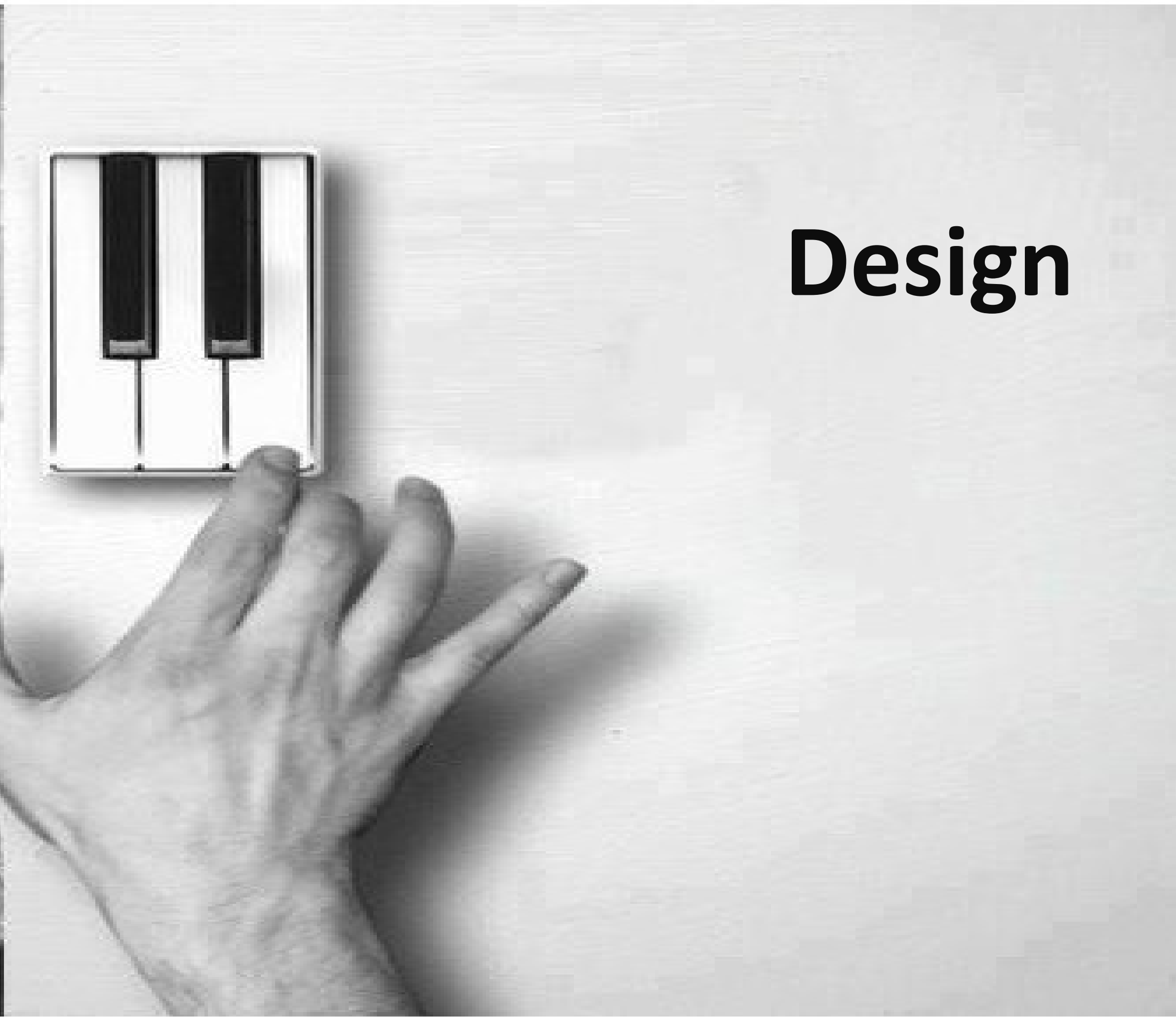

Design

Cadeira dobrável



Flexibilidade

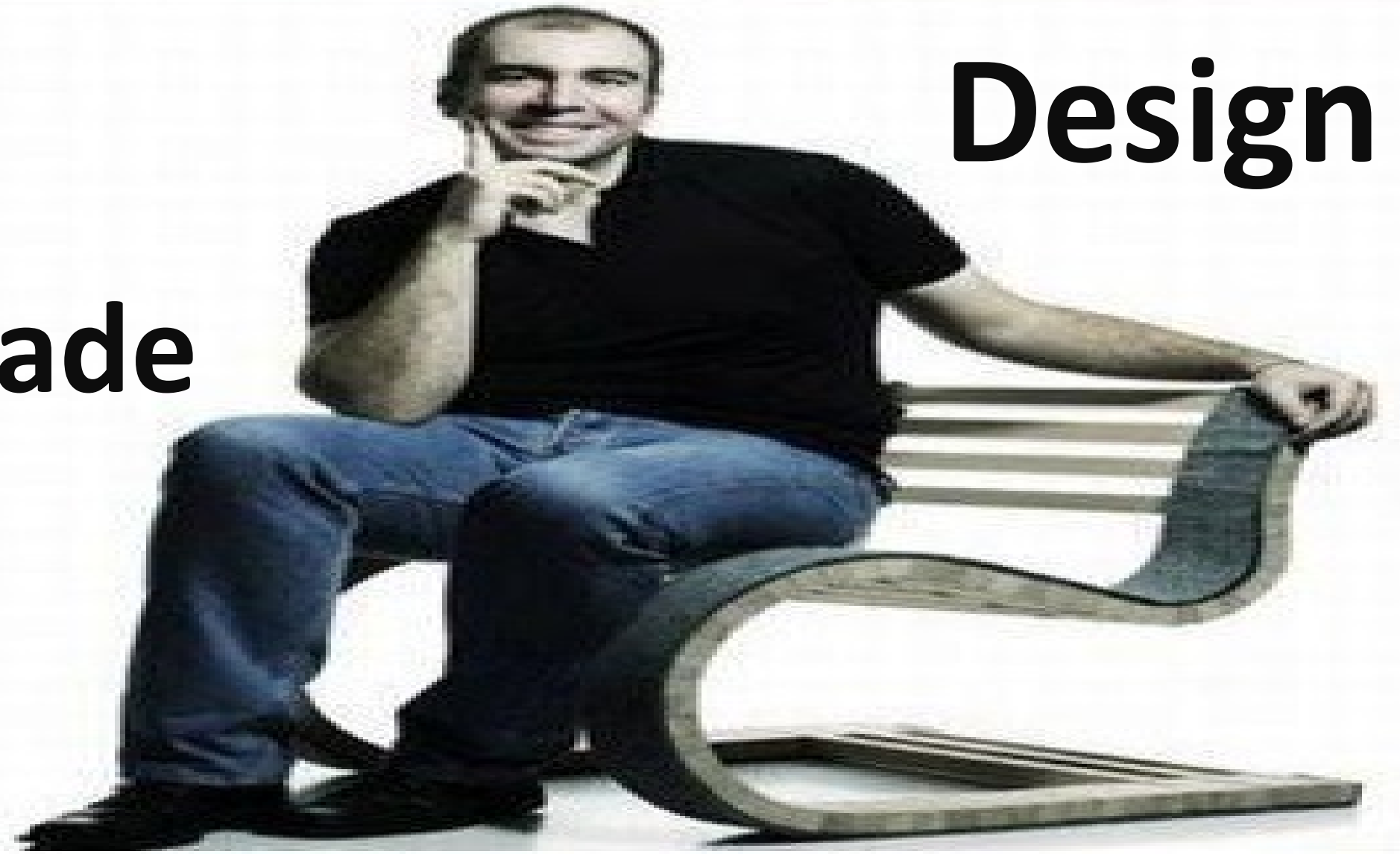

Design

Mesa de Cabeceira e Bandeja de cama



Facilidade

Mesa de Piquenique transformável



Chinelos à prova d'água para guardar itens

Funcionalidade



Guarda-chuva para duas pessoas



Funcionalidade

Móvel modular multifunções para espaços pequenos!



Flexibilidade

...nãõ

tem

FIM!!!



...começo

Obrigado...



samuel@cerumar.com.br



<https://www.facebook.com/samuel0simoes>



www.linkedin.com/in/samuelsimoes



[@samuel_simoes](https://www.instagram.com/@samuel_simoes)

www.cerumar.com.br

www.printe.com.br